

fuses & fuse holders

**ELECTRONIC**

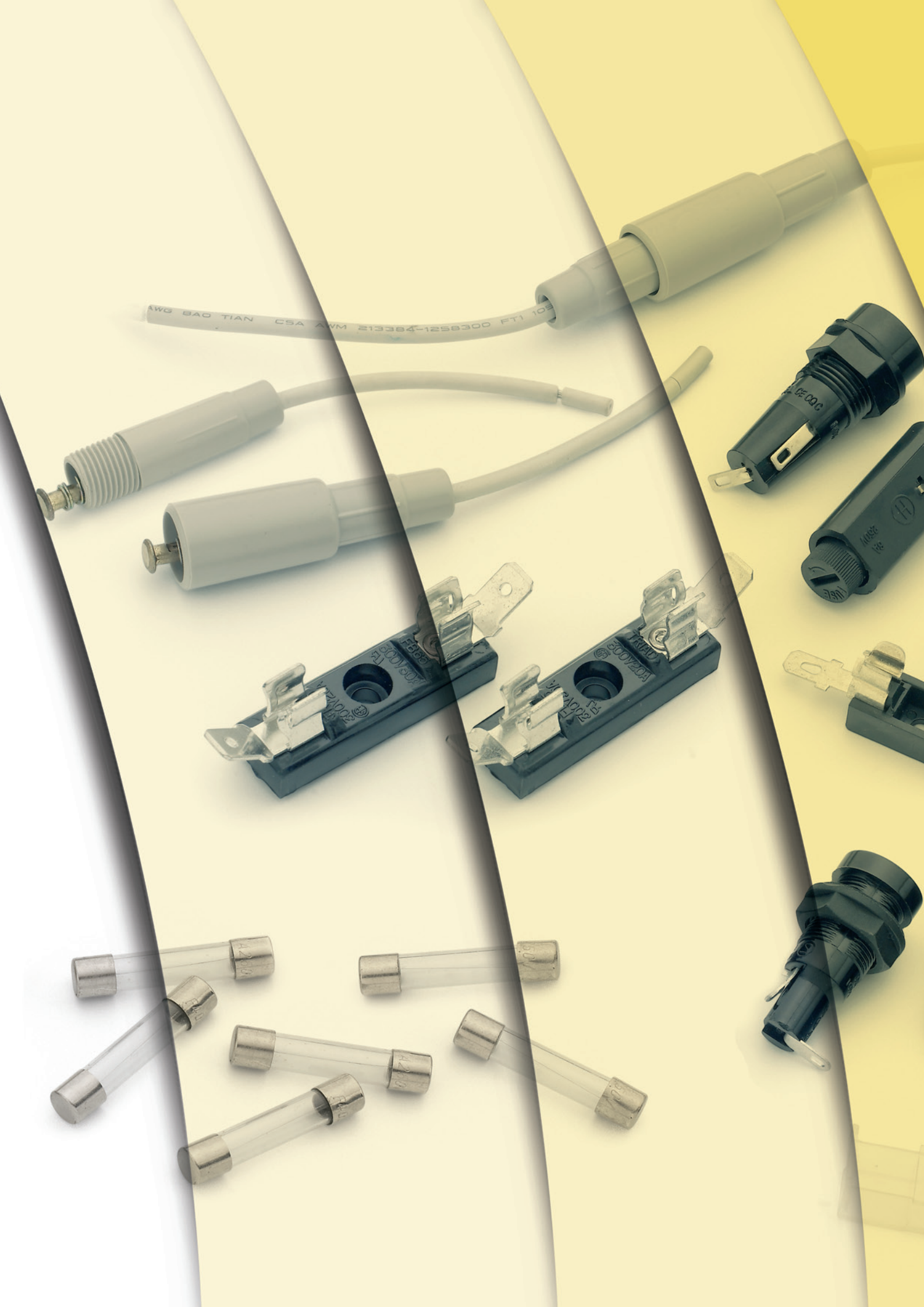



# ELECTRONIC FUSES

PAGE 04 |

5x20 MINIATURE FUSES WITH GLASS BODY  
6x32 MINIATURE FUSES WITH GLASS BODY

PAGE 05 |

PAGE 06 |

FUSE HOLDERS  
5x20 FUSE HOLDERS & BASES FOR MINIATURE FUSES  
6x32 FUSE HOLDERS & BASES FOR MINIATURE FUSES

PAGE 07 |



# ELECTRONIC GLASS BODY FUSES

## 5x20 MINIATURE FUSES WITH GLASS BODY

Glass miniature fuse links with low breaking capacity, intended for small currents. Provide protection against overloads and short circuits in electronic equipment, household, telecommunications and small transformers or motors. Available with quick acting (F) or Time lag (T) characteristics. Manufactured according to IEC and EN standards with glass tube and nickel plated copper alloy contact caps.

[www.df-sa.es/miniature/fuses/5x20/](http://www.df-sa.es/miniature/fuses/5x20/)

I <sub>n</sub> (A)	REFERENCE				U (V)	BREAKING CAPACITY (A)	PACKING Uni./BOX
	FAST ACTING (F)		TIME LAG (T)				
	BULK STANDARD	BOX STANDARD	BULK STANDARD	BOX STANDARD			
0,1	5000010	5020010	5300010	5320010	250	35	100/1000
0,125	5000012	5020012	5300012	5420012	250	35	100/1000
0,16	5000016	5020016	5300016	5420016	250	35	100/1000
0,20	5000020	5120020	5300020	5420020	250	35	100/1000
0,25	5000025	5120025	5300025	5420025	250	35	100/1000
0,315	5000031	5120031	5300031	5420031	250	35	100/1000
0,4	5000040	5120040	5300040	5420040	250	35	100/1000
0,5	5000050	5120050	5300050	5420050	250	35	100/1000
0,63	5000063	5120063	5300063	5420063	250	35	100/1000
0,8	5000080	5120080	5300080	5420080	250	35	100/1000
1	5000100	5120100	5300100	5420100	250	35	100/1000
1,25	5000125	5120125	5300125	5420125	250	35	100/1000
1,6	5000160	5120160	5300160	5420160	250	35	100/1000
2	5000200	5120200	5300200	5420200	250	35	100/1000
2,5	5000250	5120250	5300250	5420250	250	35	100/1000
3,15	5000315	5120315	5300315	5420315	250	35	100/1000
4	5000400	5120400	5300400	5420400	250	10 x I <sub>n</sub>	100/1000
5	5000500	5120500	5300500	5420500	250	10 x I <sub>n</sub>	100/1000
6,3	5000630	5120630	5300630	5420630	250	10 x I <sub>n</sub>	100/1000
7*	5000700	5020700	5300700	5320700	250	10 x I <sub>n</sub>	100/1000
8*	5000800	5020800	5300800	5320800	250	10 x I <sub>n</sub>	100/1000
10*	5001000	5021000	5301000	5321000	250	10 x I <sub>n</sub>	100/1000
12*	5001200	5021200	5301200	5321200	250	10 x I <sub>n</sub>	100/1000
15*	5001500	5021500	5301500	5321500	250	10 x I <sub>n</sub>	100/1000
16*	5001600	5021600	5301600	5321600	250	10 x I <sub>n</sub>	100/1000



\* OVERRATING FUSES

## 5x20 MINIATURE NEUTRAL LINK

REFERENCE	PACKING Uni./BOX
510001	10/100



STANDARDS IEC 60127 EN 60127	APPROVALS Cd-Pb FREE RoHS compliant
------------------------------------	---

TECHNICAL DIMENSIONS PAGE 06	TECHNICAL I-t CHARACTERISTICS PAGE 06
------------------------------------	---

COMPATIBLE FUSE HOLDERS FOR 5x20 MINIATURE FUSES PAGE 04	COMPATIBLE IN LINE FUSE HOLDERS WITH CABLE PAGE 05
---	---

# ELECTRONIC GLASS BODY FUSES

## 6x32 MINIATURE FUSES WITH GLASS BODY

Glass miniature fuse links with low breaking capacity, intended for small currents. Provide protection against overloads and short circuits in electronic equipment, household, telecommunications and small transformers or motors. Available with quick acting (F) or Time lag (T) characteristics. Manufactured according to IEC and EN standards with glass tube and nickel plated copper alloy contact caps.

[www.df-sa.es/miniature/fuses/6x32/](http://www.df-sa.es/miniature/fuses/6x32/)

I <sub>n</sub> (A)	REFERENCE				U (V)	BREAKING CAPACITY (A)	PACKING Uni./BOX
	FAST ACTING (F)		TIME LAG (T)				
	BULK STANDARD	BOX STANDARD	BULK STANDARD	BOX STANDARD			
0,1	6000010	6030010	6300010	6330010	250	35	100/1000
0,125	6000012	6030012	6300012	6330012	250	35	100/1000
0,16	6000016	6030016	6300016	6330016	250	35	100/1000
0,20	6000020	6030020	6300020	6330020	250	35	100/1000
0,25	6000025	6030025	6300025	6330025	250	35	100/1000
0,315	6000031	6030031	6300031	6330031	250	35	100/1000
0,4	6000040	6030040	6300040	6330040	250	35	100/1000
0,5	6000050	6030050	6300050	6330050	250	35	100/1000
0,63	6000063	6030063	6300063	6330063	250	35	100/1000
0,8	6000080	6030080	6300080	6330080	250	35	100/1000
1	6000100	6030100	6300100	6330100	250	35	100/1000
1,25	6000125	6030125	6300125	6330125	250	35	100/1000
1,6	6000160	6030160	6300160	6330160	250	35	100/1000
2	6000200	6030200	6300200	6330200	250	35	100/1000
2,5	6000250	6030250	6300250	6330250	250	35	100/1000
3,15	6000315	6030315	6300315	6330315	250	35	100/1000
4	6000400	6030400	6300400	6330400	250	10 x I <sub>n</sub>	100/1000
5	6000500	6030500	6300500	6330500	250	10 x I <sub>n</sub>	100/1000
6,3	6000630	6030630	6300630	6330630	250	10 x I <sub>n</sub>	100/1000
7*	6000700	6030700	6300700	6330700	250	10 x I <sub>n</sub>	100/1000
8*	6000800	6030800	6300800	6330800	250	10 x I <sub>n</sub>	100/1000
9*	6000900	6030900	6300900	6330900	250	10 x I <sub>n</sub>	100/1000
10*	6001000	6031000	6301000	6331000	250	10 x I <sub>n</sub>	100/1000
12*	6001200	6031200	6301200	6331200	250	10 x I <sub>n</sub>	100/1000
15*	6001500	6031500	6301500	6331500	250	10 x I <sub>n</sub>	100/1000

\* OVERRATING FUSES



## 5x20 6x32 MINIATURE FUSES SET

SIZE	REFERENCE		PACKING Uni./BOX
	FAST ACTING (F)	TIME LAG (T)	
5x20	510002*	510003*	1/10
6x32	510004*	-	1/10

\* THIS SET CONTAINS 20 GLASS FUSES OF EVERY RATED CURRENT.

I<sub>n</sub> (A): 125 mA · 160 mA · 200 mA · 250 mA · 315 mA · 400 mA · 500 mA · 630 mA · 800 mA · 1 A · 1,25 A · 1,6 A · 2 A · 2,5 A · 3,15 A · 4 A · 5 A · 6,3 A



510002

STANDARDS IEC 60127 EN 60127	APPROVALS Cd-Pb RoHS compliant GREEN
------------------------------------	--

TECHNICAL DIMENSIONS PAGE 06	TECHNICAL t-I CHARACTERISTICS PAGE 06
------------------------------------	---

COMPATIBLE FUSE HOLDERS FOR 6x32 MINIATURE FUSES PAGE 05	COMPATIBLE IN LINE FUSE HOLDERS WITH CABLE PAGE 05
---	---

## 5x20 FUSE HOLDERS & BASES FOR MINIATURE FUSES

Fuse holders for 5x20 size miniature fuses. Models with fuse clip contacts, for mounting panel or in-line.  
[www.df-sa.es/miniature/fuseholders/5x20/](http://www.df-sa.es/miniature/fuseholders/5x20/)

REFERENCE	FIXING TYPE · DESCRIPTION	$I_n$ (A)	U (V)	PACKING Uni./BOX
515020	PANEL MOUNTING SCREW FUSE CARRIER	6,3	250	10/100
515025	PANEL MOUNTING SCREW FUSE CARRIER	6,3	250	10/100
515030	SCREW MOUNTING CLIP CONTACT	6,3	250	10/100
515045	PRINTED CIRCUIT BOARD BAYONET FUSE CARRIER (V)	6,3	250	10/100
515050	PRINTED CIRCUIT BOARD BAYONET FUSE CARRIER (H)	6,3	250	10/100
515055	PANEL MOUNTING BAYONET FUSE CARRIER	6,3	250	10/100
515060	PRINTED CIRCUIT BOARD	6,3	250	10/100



# ELECTRONIC FUSE HOLDERS & BASES

## 6x32 FUSE HOLDERS & BASES FOR MINIATURE FUSES

Fuse holders for 6x32 size miniature fuses. Models with fuse clip contacts, for mounting panel or in-line.

[www.df-sa.es/miniature/fuseholders/6x32/](http://www.df-sa.es/miniature/fuseholders/6x32/)

REFERENCE	FIXING TYPE · DESCRIPTION	I <sub>n</sub> (A)	U (V)	PACKING Uni./BOX
516032	PANEL MOUNTING SCREW FUSE CARRIER	16	250	10/100
516035	SCREW MOUNTING	25	250	10/100



## 5x20 6x32 IN LINE FUSE HOLDERS WITH CABLE

REFERENCE	FIXING TYPE · DESCRIPTION	I <sub>n</sub> (A)	U (V)	PACKING Uni./BOX
516045*	IN LINE FUSE HOLDER WITH CABLE	6,3	250	10/100



\* THIS FUSE HOLDER ACCEPTS MINIATURE FUSE LINKS 5x20 AND 6x32

STANDARDS IEC 60127 EN 60127	APPROVALS RoHS compliant REACH compliant
------------------------------------	--

TECHNICAL DIMENSIONS PAGE 08
------------------------------------

COMPATIBLE 5x20 MINIATURE FUSES WITH GLASS BODY PAGE 02
--

COMPATIBLE 6x32 MINIATURE FUSES WITH GLASS BODY PAGE 03
--

# ELECTRONIC GLASS BODY FUSES

TECHNICAL  
**5x20** MINIATURE FUSES WITH GLASS BODY  
**6x32** DIMENSIONS

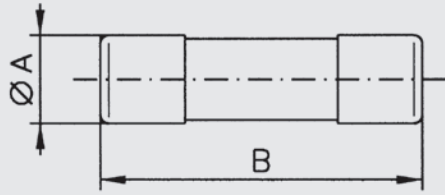

SIZE	A	B
5x20	5	20
6x32	6	32

TECHNICAL  
**5x20** MINIATURE FUSES WITH GLASS BODY  
t-I CHARACTERISTICS

**CLASS F**  
FAST  
ACTING

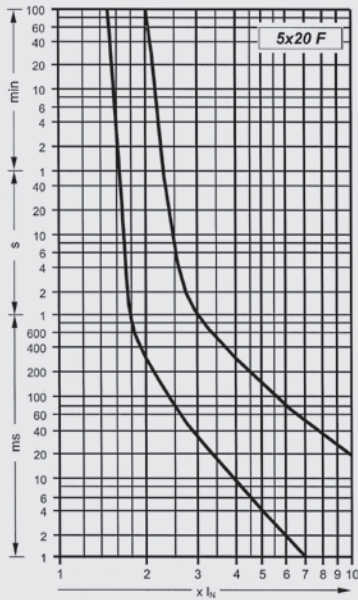

**CLASS T**  
TIME  
LAG

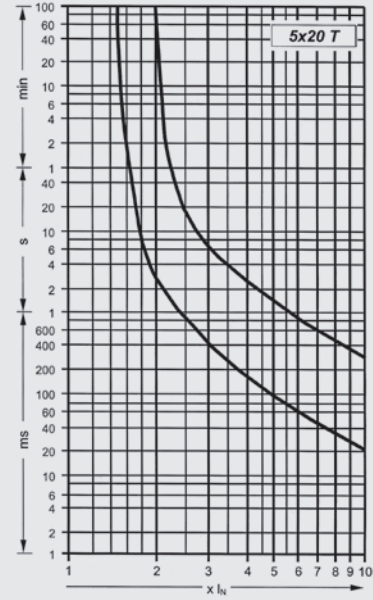

TECHNICAL  
**6x32** MINIATURE FUSES WITH GLASS BODY  
t-I CHARACTERISTICS

**CLASS F**  
FAST  
ACTING

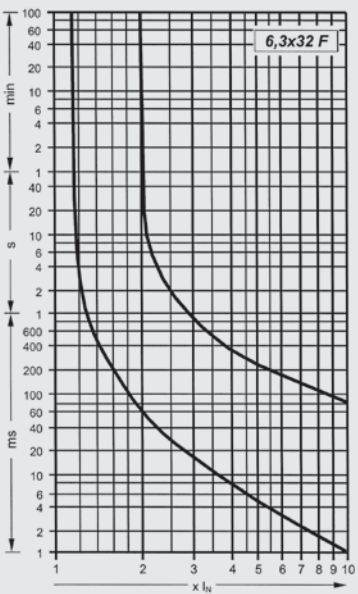

**CLASS T**  
TIME  
LAG

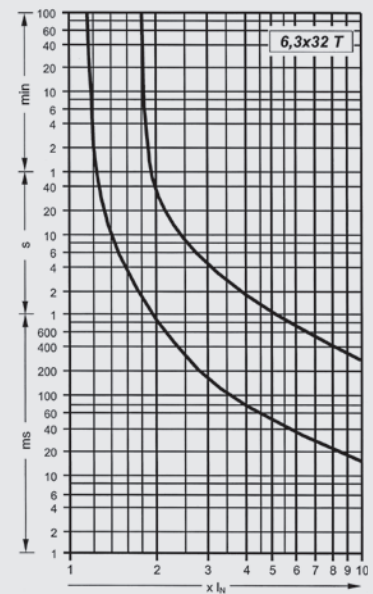





TECHNICAL  
**6x32** FUSE HOLDERS & BASES FOR MINIATURE FUSES  
 DIMENSIONS

516032

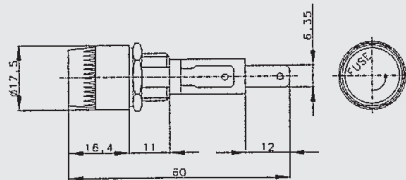

516035

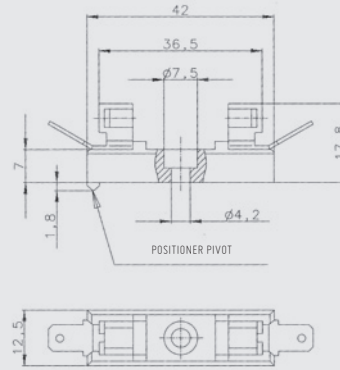

TECHNICAL  
**5x20** IN LINE FUSE HOLDERS WITH CABLE  
**6x32** DIMENSIONS

516045

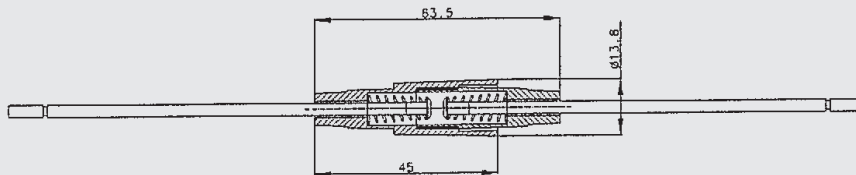



**HEAD OFFICE & FACTORY**

SILICI, 67-69

08940 CORNELLA DE LLOBREGAT

BARCELONA

SPAIN

Tel. +34 93 377 85 85

Fax +34 93 377 82 82

**EXPORT SALES**

Tel. +34 93 475 08 64

Fax +34 93 480 07 75

[export@df-sa.es](mailto:export@df-sa.es)

**NATIONAL SALES**

Tel. 93 475 08 64

Fax 93 480 07 76

[comercial@df-sa.es](mailto:comercial@df-sa.es)

[www.df-sa.es/miniature](http://www.df-sa.es/miniature)